

Pasillos Tematizados

Carlos Pellegrini

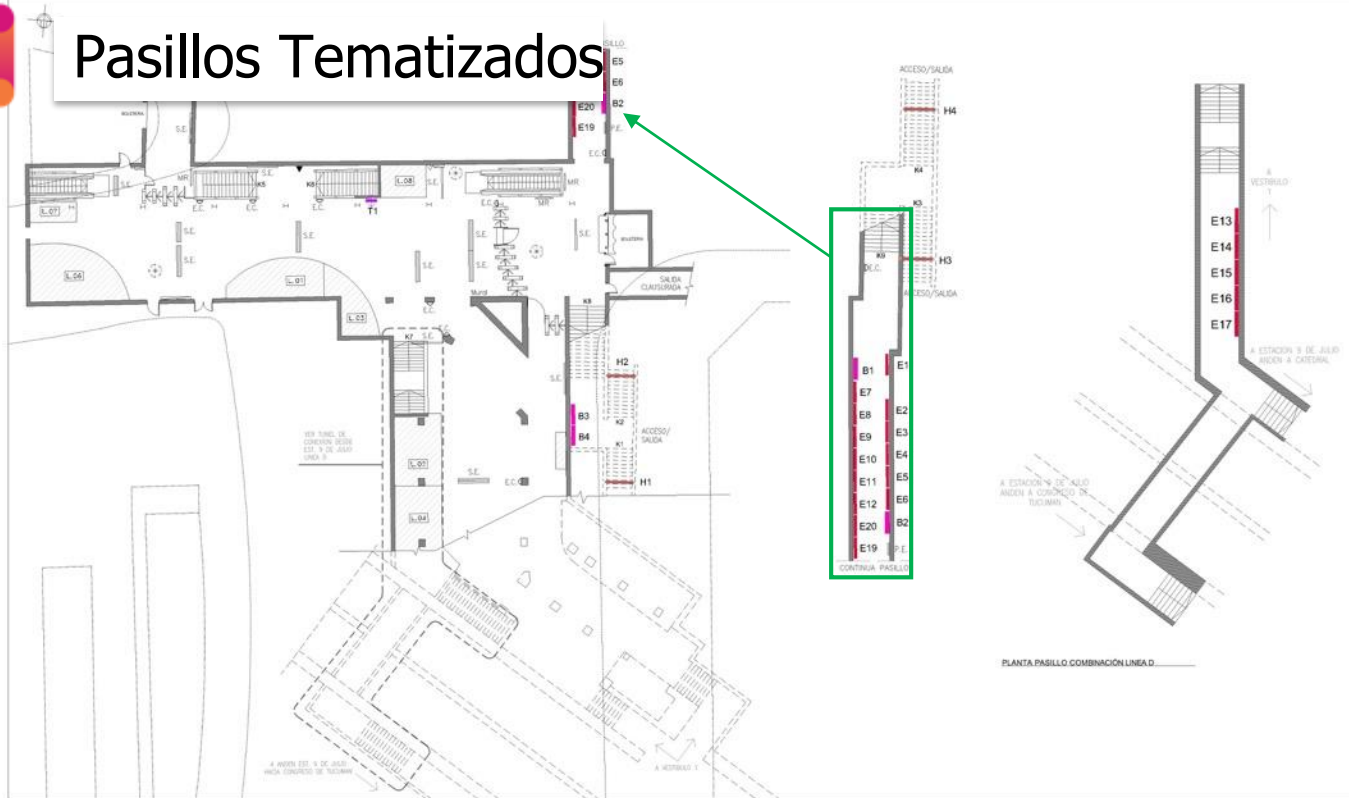

NOMENCLATURA DE LOS CARTELES PUBLICITARIOS					
Estático Super Borde Recto	A		SUBTV	T.V.	
Estático Super Media Caña	A		Indicador de Andén	I.A.	
Estático Super: marco sup. rectangular	A		Estático Up	H	
Estático Light Horizontal	B		Estático Up Ascensor	H	
Estático Light Vertical	C		Cartelera en Escaleras	F	
Estático Light Horizontal Doble Foz	D		Promostep	K	
Estático Classic	E		Acción Ciudadana	A.C.	
Afiche Doble Foz con Asiento	D				
Digital Light	T				

ESTATIC		
TITULO DEL PLANO		
EST. C. PELLEGRINI		
LINEA B		
PLANTA NIVEL VESTIBULO		
ÚLTIMA REVISIÓN	OBSERVACIONES	CODIGO DE ESTACION
Julio 2018	Estación no Tematizado	B-03-CP

Pasillos Tematizados: Salida H3/H4

Carlos Pellegrini

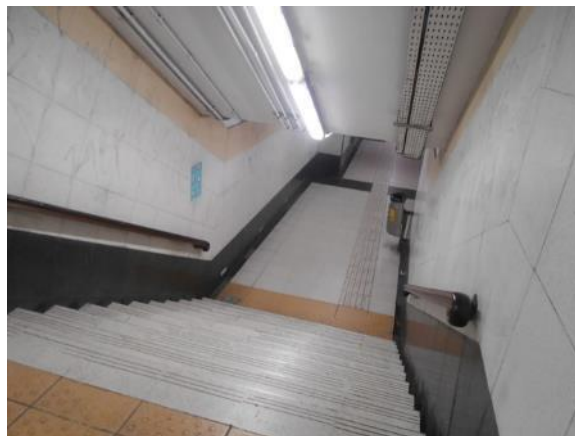

Pasillos Tematizados: Medidas Salida H3/H4

Carlos Pellegrini

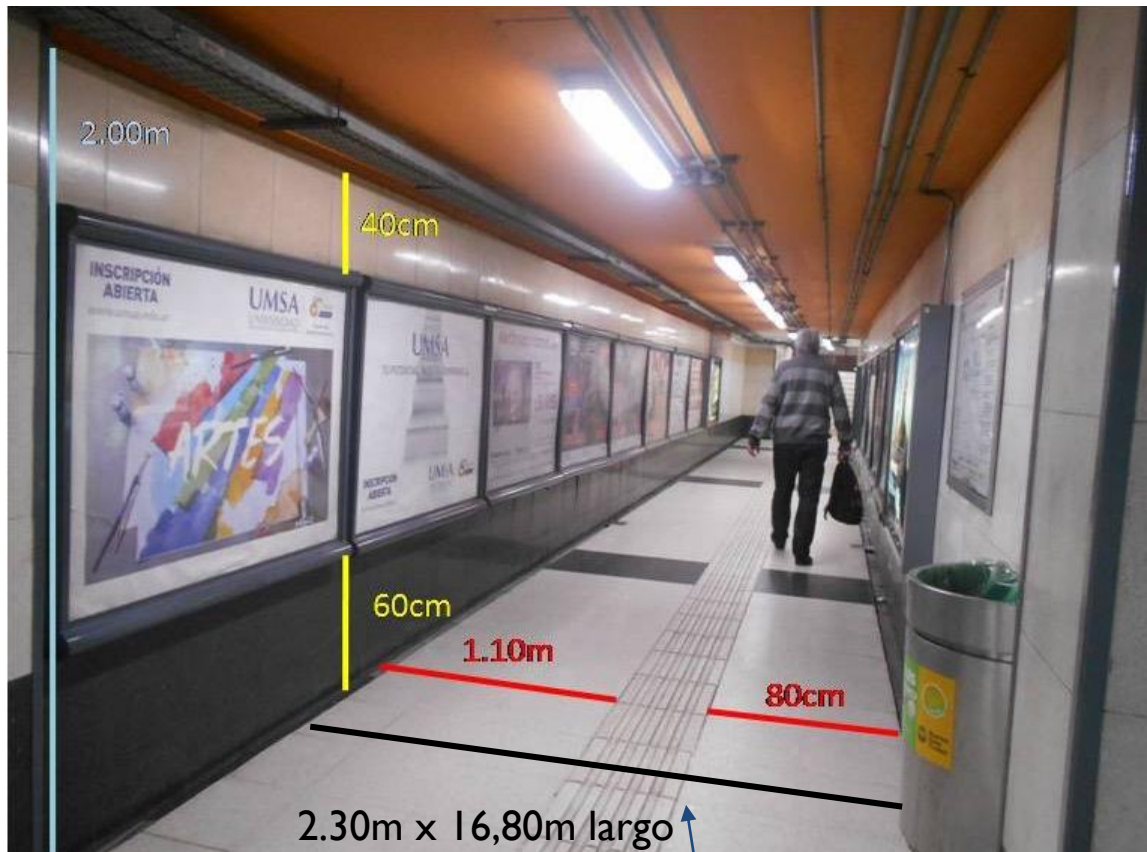

*No se permite plotear la guía para no videntes.



No se puede plotear

Croquis desde arriba



Salida



Vestibulo





Pasillos Tematizados: Medidas Salida H3/H4

Lado derecho desde vestíbulo

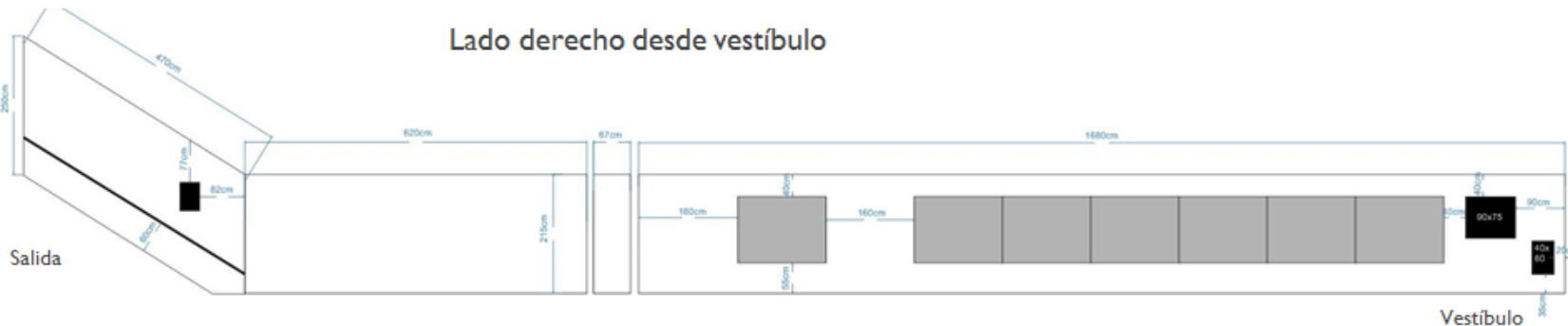

Lado izquierdo desde vestíbulo



Pasillos Tematizados: Medidas Salida H3/H4

Carlos Pellegrini

Extensión Pasillo Pellegrini

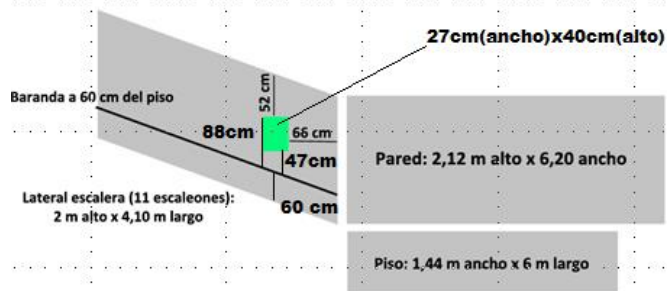

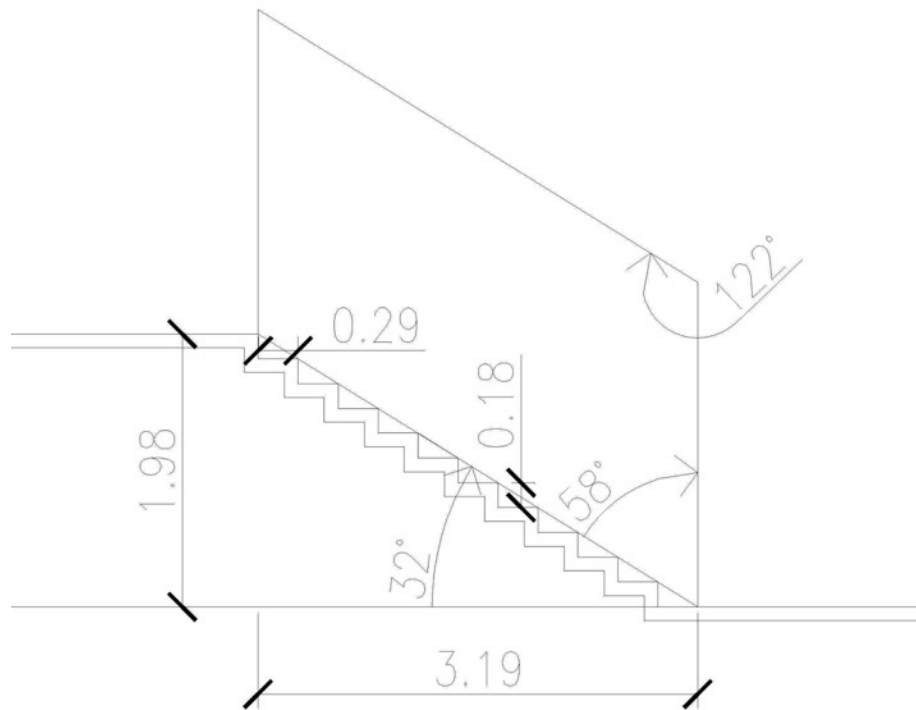
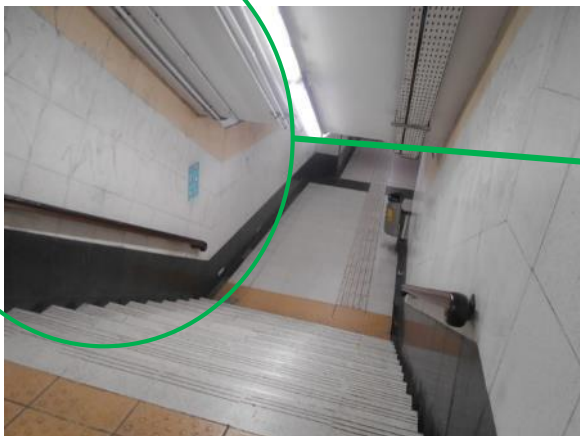

Pasillos Tematizados: Acciones Realizadas

Carlos Pellegrini



Pasillos Tematizados: LÍNEA C - Salida H1

Independencia

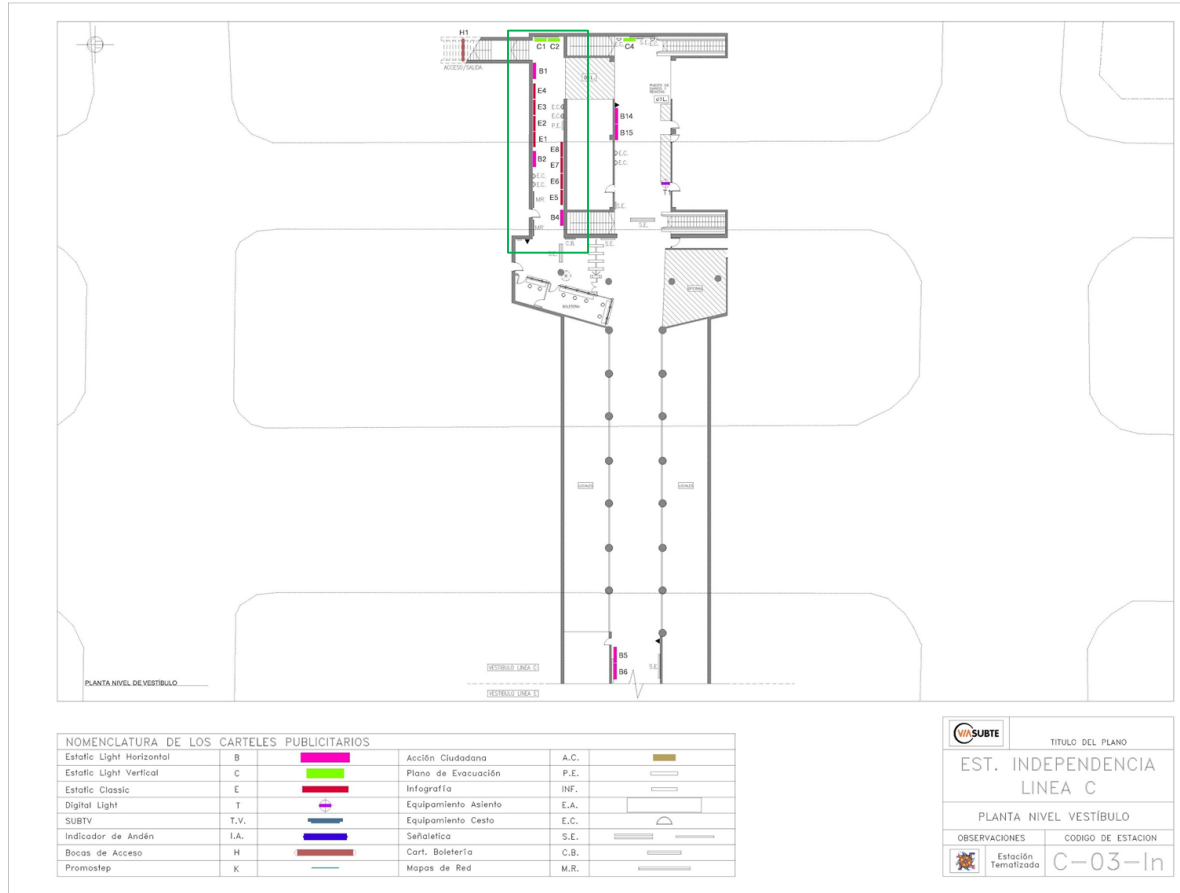

Pasillos Tematizados: LÍNEA C - Salida H1

Independencia





Pasillos Tematizados: Medidas salida H1

Independencia

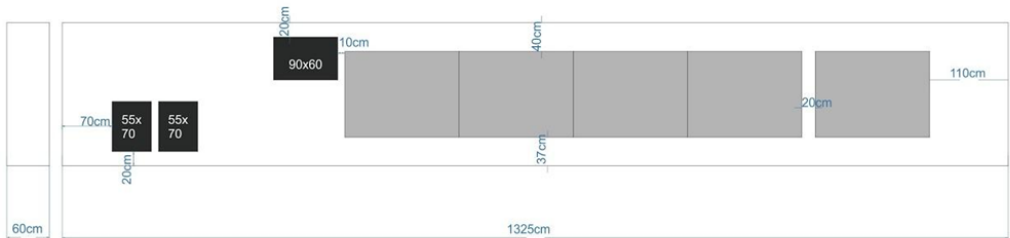
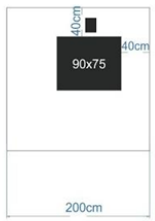
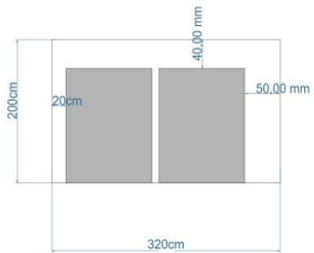

Pasillos Tematizados

Palermo

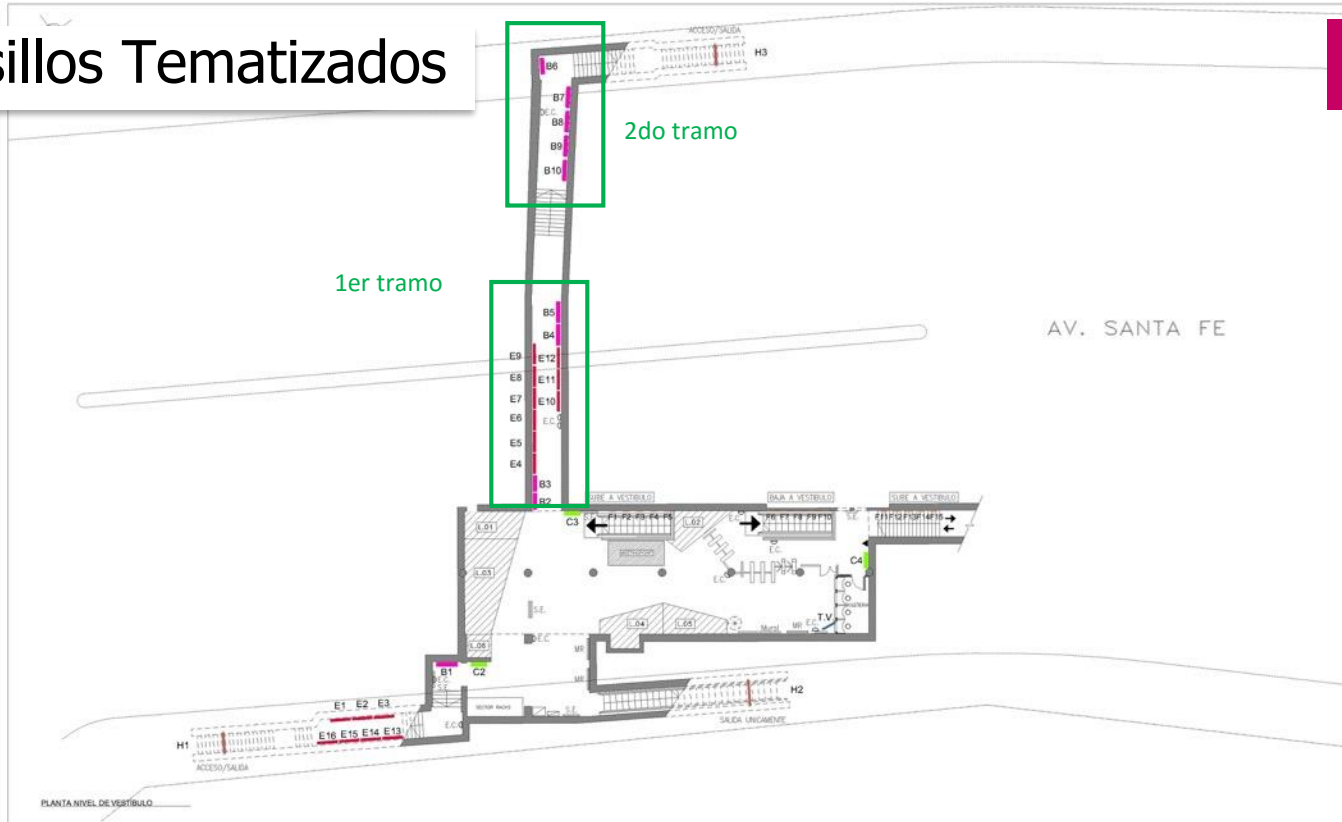

NOMENCLATURA DE LOS CARTELES PUBLICITARIOS

Estafic Super	A		Doble Faz Entrevías	D	
Estafic Super VIP Nuevos	A		Indicador de Andén	I.A.	
Estafic Super VIP Viejos	A		Bocas de Acceso	H	
Estafic Light Vertical	C		Promostep	K	
Estafic Light Horizontal	B		Atención Ciudadana	A.C.	
Digital Light	T		Plano de Evacuación	P.E.	
Estafic Classic	E		Equipamiento Asiento	E.A.	
Cartelera en Escaleras	F		Señalética	S.E.	
SUBTV	T.V.		Mapas de Red	M.R.	

TITULO DEL PLANO

EST. PALERMO
LINEA D

PLANTA NIVEL ANDEN

OBSERVACIONES	CODIGO DE ESTACION
Estación Tematizada	D-12-Pa

Pasillos Tematizados: Salida H3 – Primer Tramo

Palermo

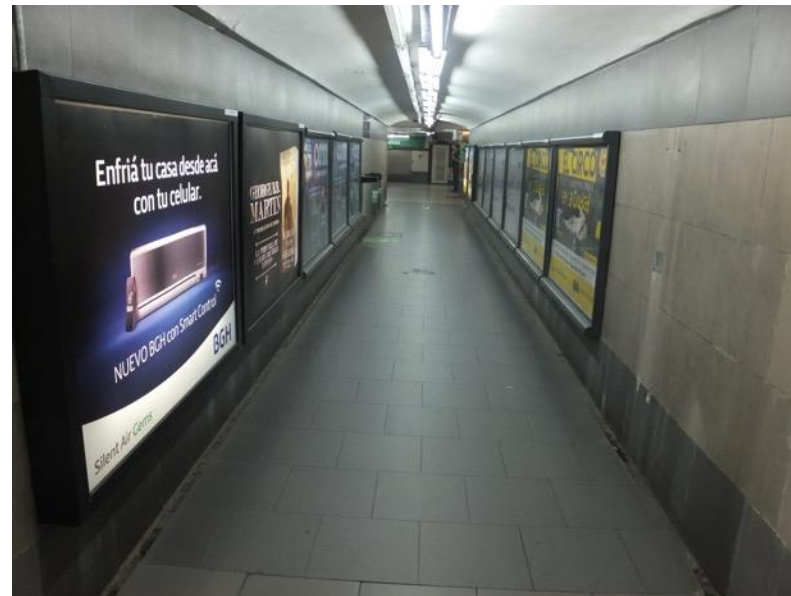

Pasillos Tematizados: Medidas Salida H3 – 1er Tramo Palermo

Lado izquierdo desde vestíbulo



vestíbulo

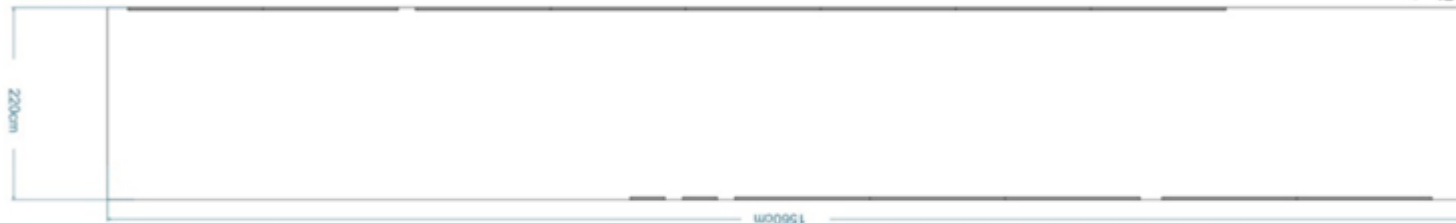

Salida



Lado derecho desde vestíbulo

Pasillos Tematizados: Medidas Salida H3 – 2do. Tramo Palermo

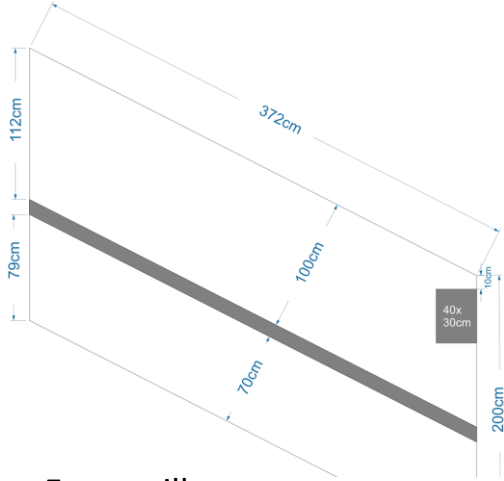

Laterales Esc. pasillo

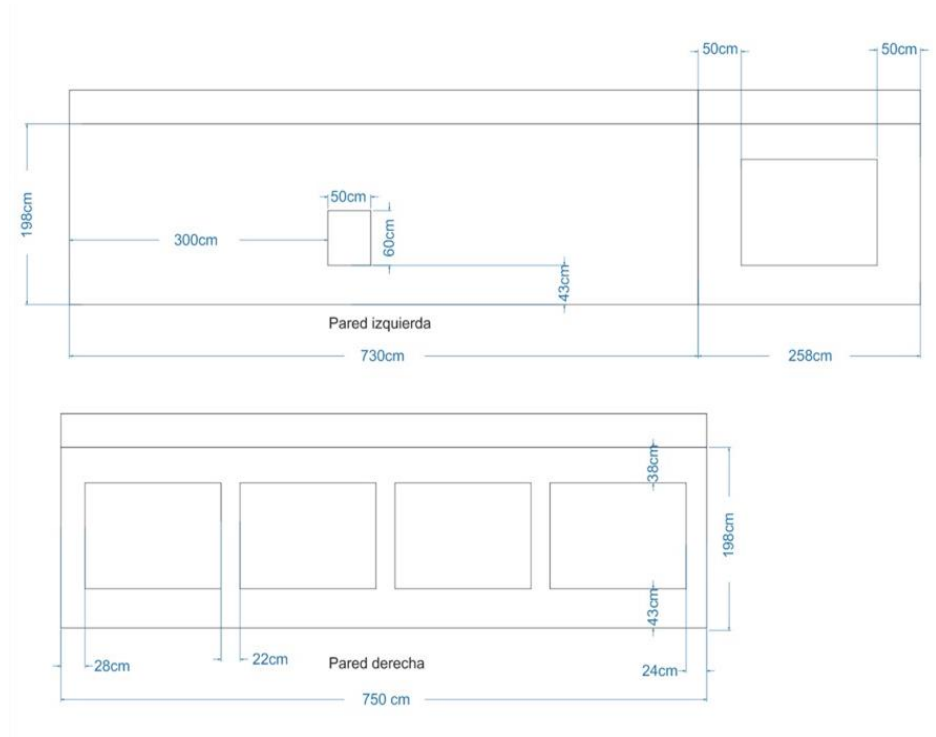
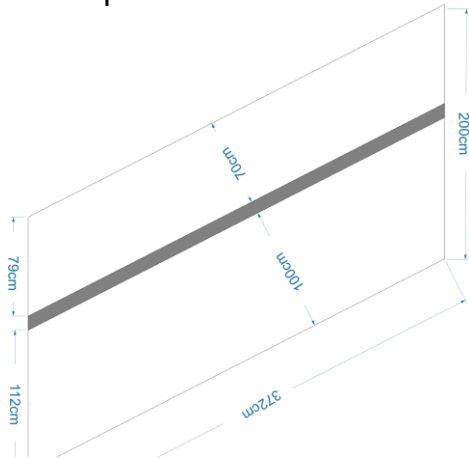

Pasillos Tematizados: Salida H3 – Segundo Tramo

Palermo



Pasillos Tematizados: Acciones Realizadas

Palermo

