



Lateral de Escalera

Se detallan Specs por Estación.

FORMATO ORIGINALES: JPG a igual tamaño a 100dpi



Lateral de Escalera

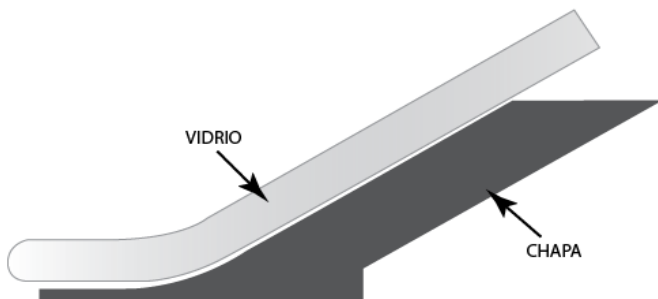
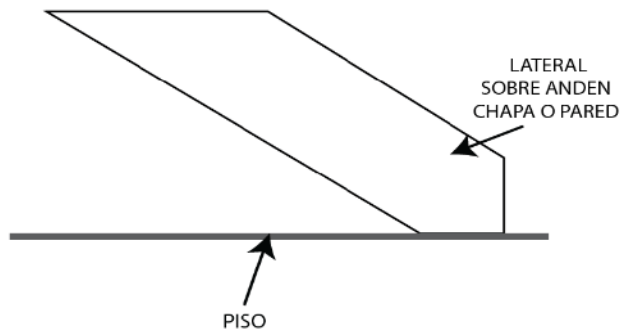

Lateral de Escalera: LÍNEA A

Puán



NOMENCLATURA DE LOS CARTELES PUBLICITARIOS					
Estatic Light Horizontal	B		Atención Ciudadana	A.C.	
Estatic Classic	E		Plano de Evacuación	P.E.	
SUBTV	T.V.		Equipamiento Asiento	E.A.	
Indicador de Andén	I.A.		Equipamiento Cesto	E.C.	
Boca de Acceso	H		Señalética	S.E.	
Promostep	K		Mapas de Red	M.R.	

	TÍTULO DEL PLANO
EST. PUAN LINEA A	
PLANTA NIVEL ANDÉN	
OBSERVACIONES	CODIGO DE ESTACION
Estación Tematizada	A-15-Pu



Lateral de Escalera: Ubicación hacia Pza. de Mayo

Puán

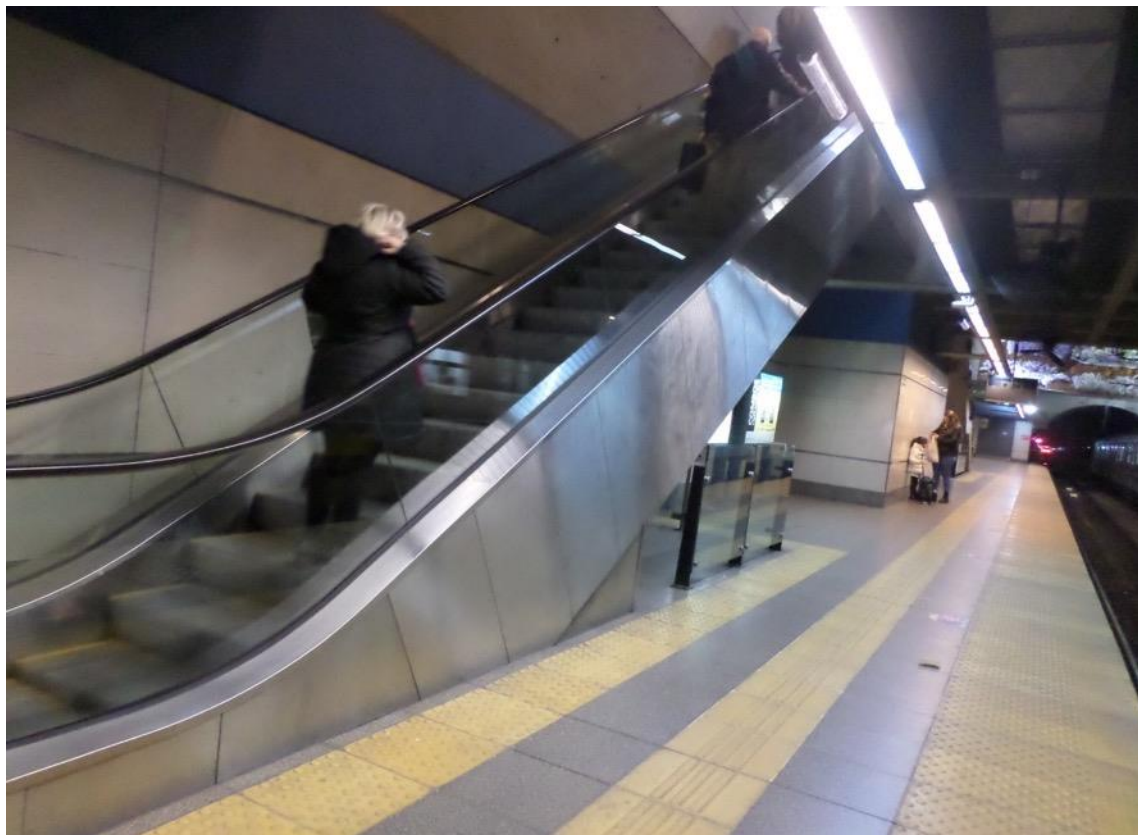



Lateral de Escalera: Ubicación hacia San Pedrito

Puán

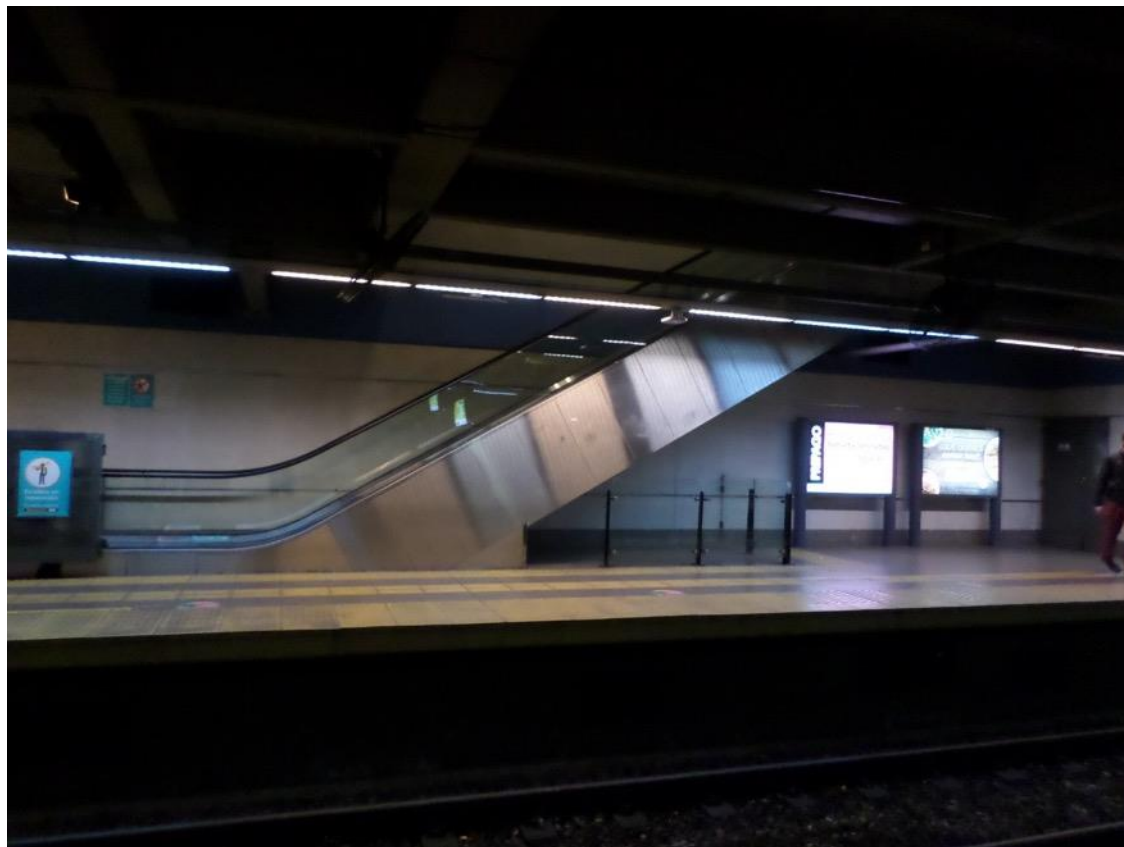



Lateral de Escalera: Medidas

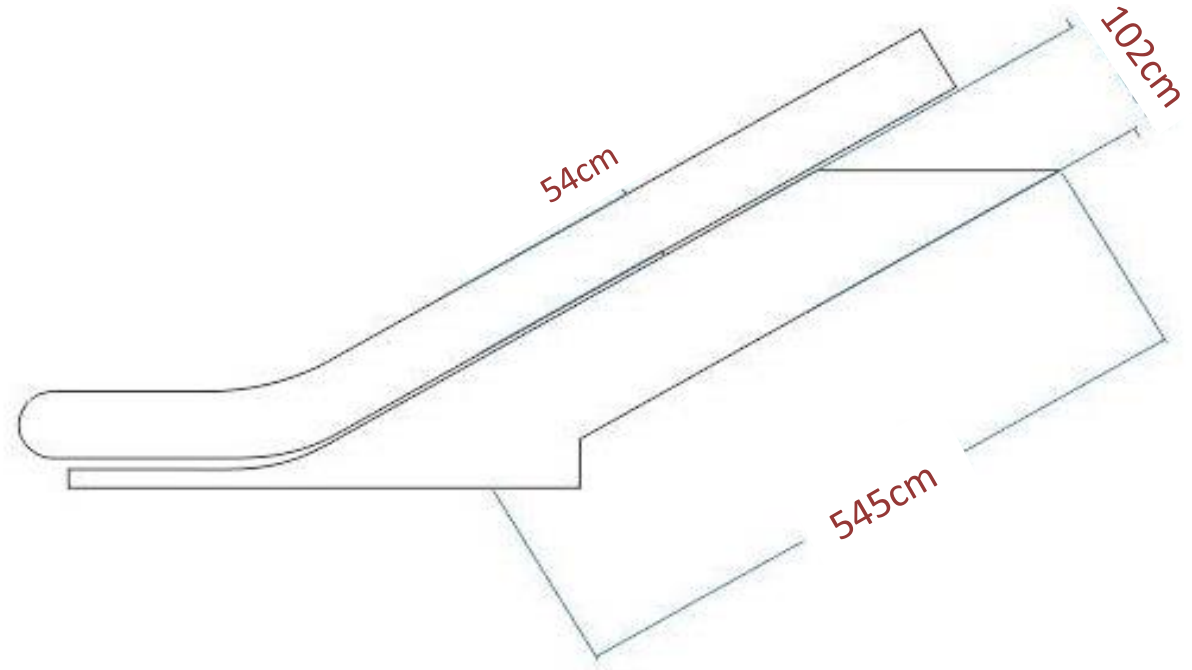

Lateral de Escalera



NOMENCLATURA DE LOS CARTELES PUBLICITARIOS

Estatic Light Horizontal	B		Atención Ciudadana	A.C.	
Estatic Classic	E		Plano de Evacuación	P.E.	
SUBTV	T.V.		Equipamiento Asiento	E.A.	
Indicador de Andén	I.A.		Equipamiento Cesto	E.C.	
Boca de Acceso	H		Señalética	S.E.	
Promostep	K		Mapas de Red	M.R.	

TITULO DEL PLANO
EST. CARABOBO
LINEA A
 PLANTA NIVEL ANDEN
 OBSERVACIONES: Estación Tematizada
 CODIGO DE ESTACION: **A-16-Ca**



Lateral de Escalera: Ubicación hacia Pza. de Mayo

Carabobo

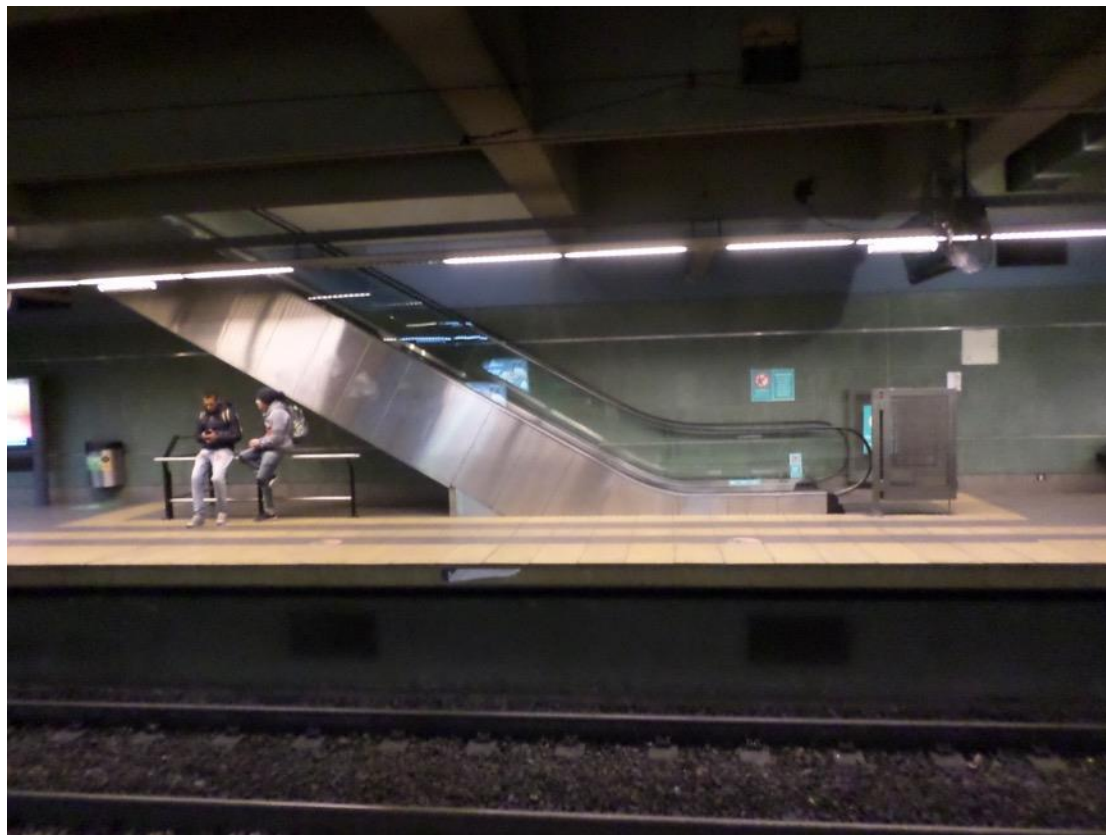

Lateral de Escalera: Ubicación hacia San Pedrito

Carabobo

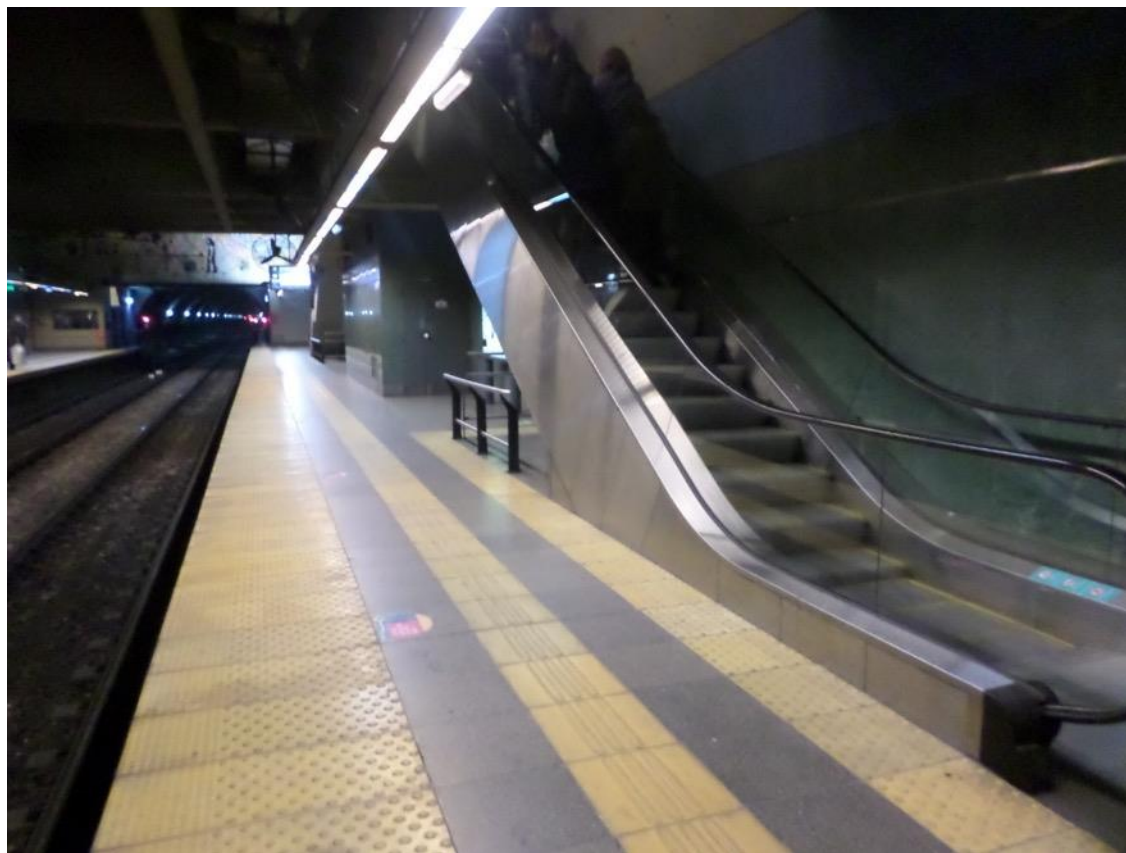



Lateral de Escalera: Acciones Realizadas

Carabobo

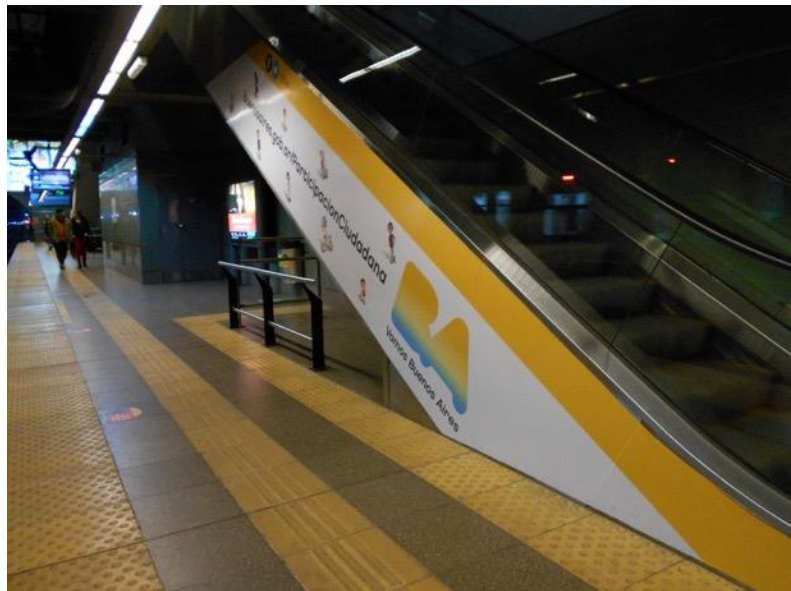



Lateral de Escalera: Medidas

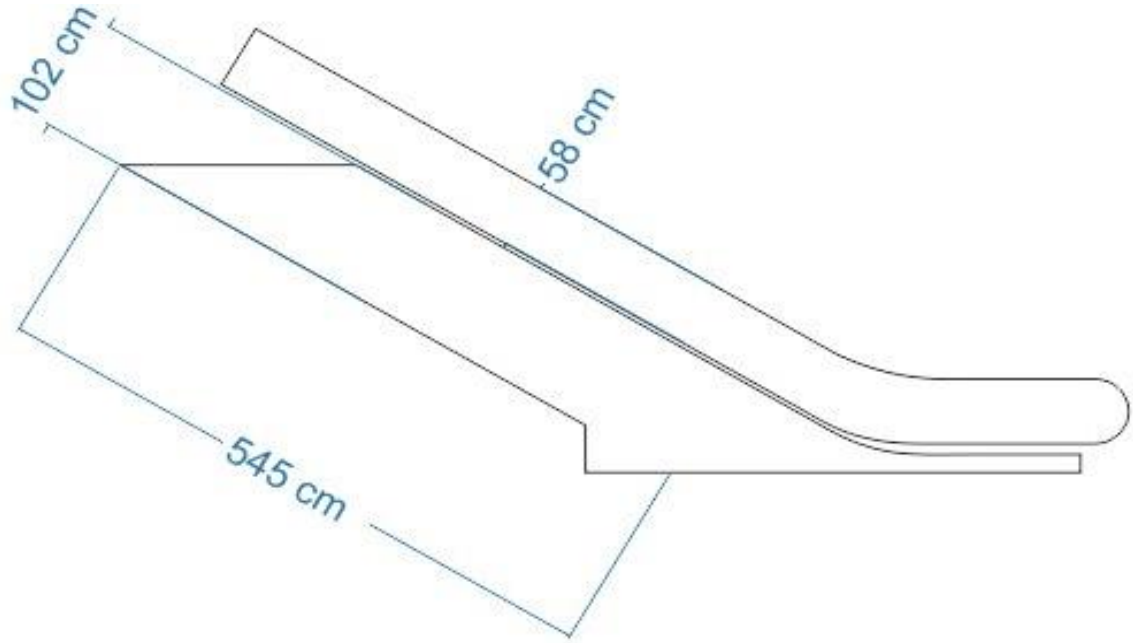

Lateral de Escalera: LÍNEA B

VISTA ANDÉN L.N. ALEM

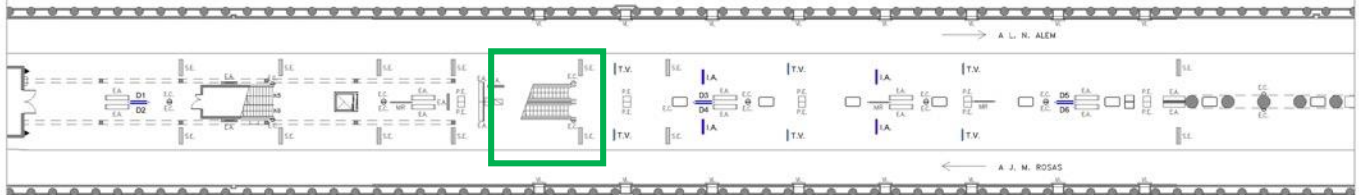

PLANTA NIVEL DE ANDÉN

VISTA ANDÉN J. M. ROSAS

NOMENCLATURA DE LOS CARTELES PUBLICITARIOS					
Estatic Light Horizontal	B		Atención Ciudadana	A.C.	
Estatic Light Vertical	C		Plano de Evacuación	P.E.	
Doble Faz Entrevías	D		Reja	R.	
Estatic Classic	E		Infografía	INF.	
SUBTV	T.V.		Equipamiento Asiento	E.A.	
Indicador de Andén	I.A.		Equipamiento Cesto	E.C.	
Bocas de Acceso	H		Señalética	S.E.	
Promostep	K		Mapas de Red	M.R.	

	TITULO DEL PLANO	
EST. LOS INCAS LINEA B		
VISTAS ANDENES	PLANTA NIVEL ANDEN	
OBSERVACIONES	CODIGO DE ESTACION	
Estación no Tematizada	B-16-L.I	

Lateral de Escalera: Ubicación Hacia LN. Alem

Los Incas



Lateral de Escalera: Ubicación hacia JM. Rosas

Los Incas



Lateral de Escalera: Acciones Realizadas

Los Incas

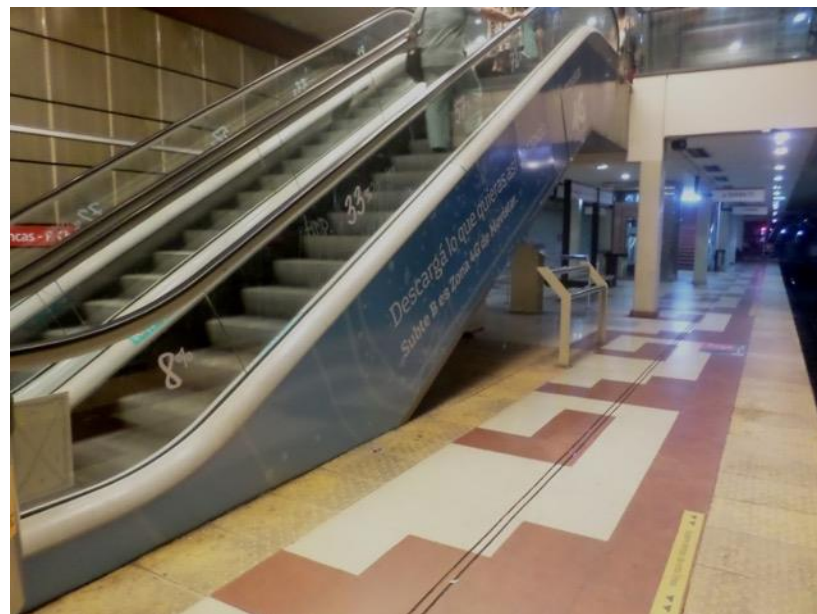



Lateral de Escalera: Medidas: Hacia JM. Rosas

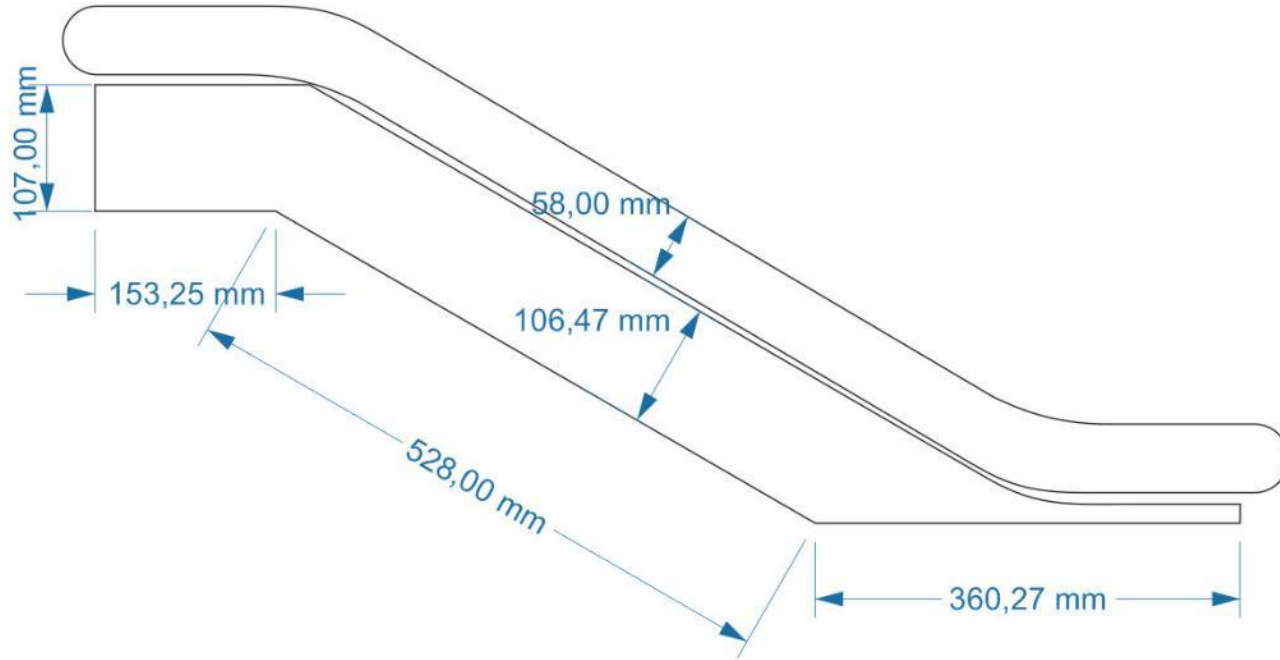



Lateral de Escalera: Medidas: Hacia LN. Alem

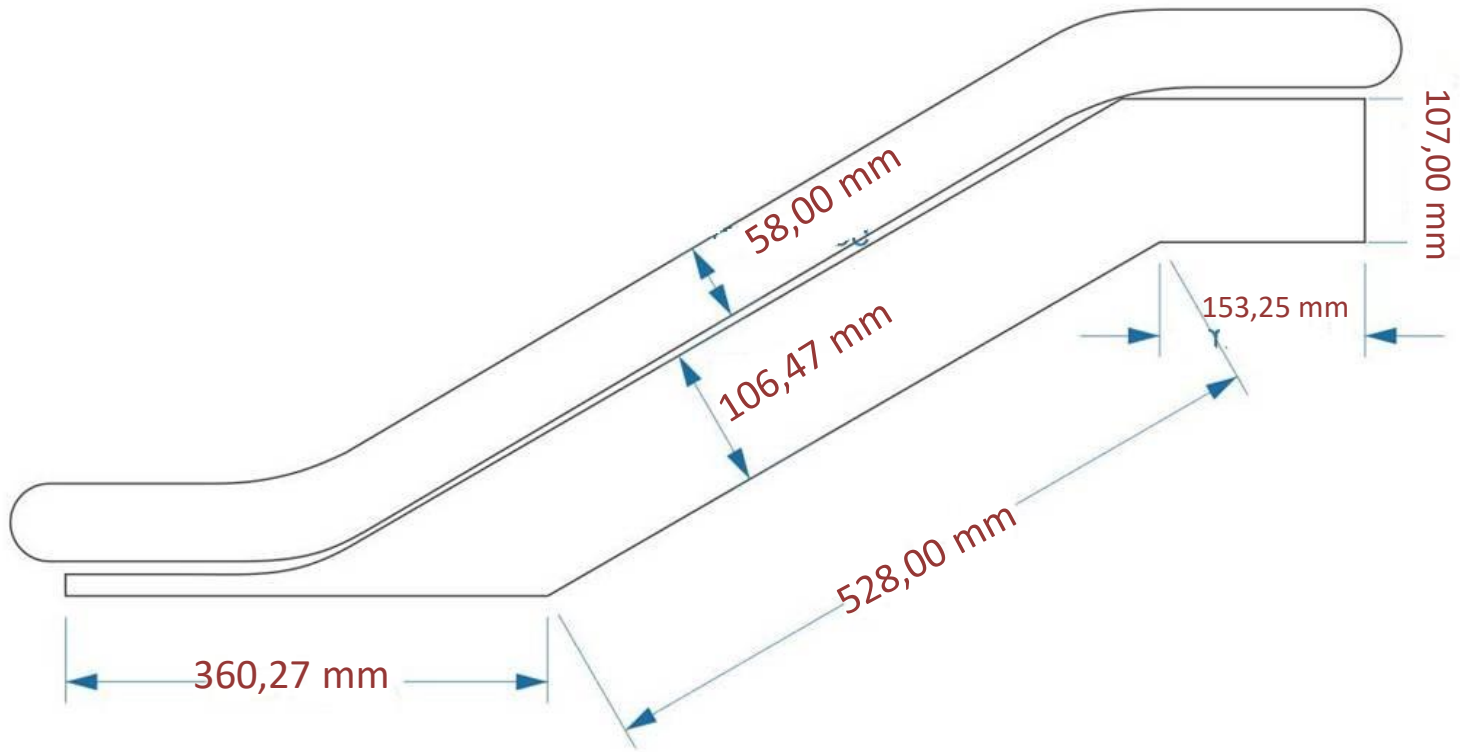

Lateral de Escalera

JM. Rosas

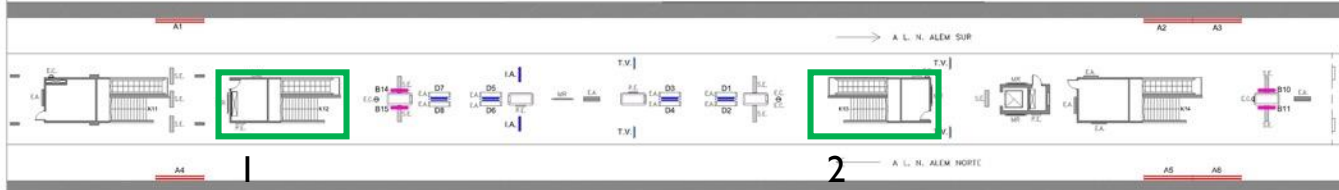

PLANTA NIVEL DE ANDÉN

NOMENCLATURA DE LOS CARTELES PUBLICITARIOS

Estafic Super: marco sup. plano	A		Promostep	K	
Estafic Light Horizontal	B		Acción Ciudadana	A.C.	
Estafic Light Vertical	C		Piano de Evacuación	P.E.	
Doble Faz Entrevías	D		Reja	R.	
Estafic Classic	E		Equipamiento Asiento	E.A.	
Digital Light	T		Señalética	S.E.	
SUBTV	T.V.		Cart. Boletería	C.B.	
Indicador de Andén	I.A.		Mapas de Red	M.R.	
Boca de Acceso	H				

	TÍTULO DEL PLANO
EST. J. M. ROSAS LINEA B	
PLANTA NIVEL ANDÉN	
OBSERVACIONES	CODIGO DE ESTACION
Estación no Tematizada	B-18-Ro

Lateral de Escalera

JM. Rosas

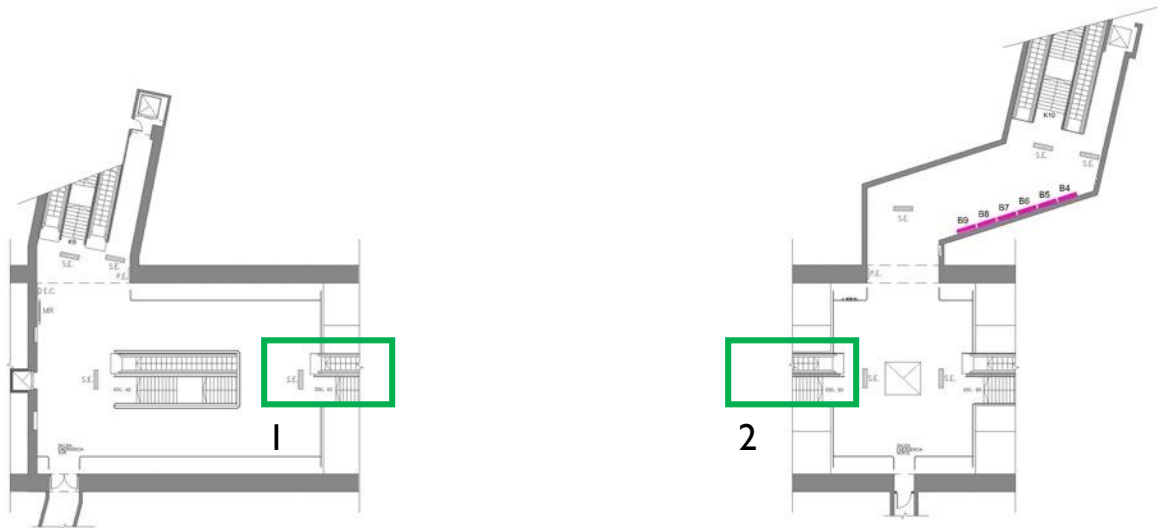

PLANTA NIVEL VESTIBULO MEDIOS

NOMENCLATURA DE LOS CARTELES PUBLICITARIOS					
Estatico Super: marco sup. plano	A		Promostep	K	
Estatic Light Horizontal	B		Acción Ciudadana	A.C.	
Estatic Light Vertical	C		Piano de Evacuación	P.E.	
Doble Faz Entrevías	D		Rejo	R.	
Estatic Classic	E		Equipamiento Asiento	E.A.	
Digital Light	T		Señaletica	S.E.	
SUBTV	T.V.		Cart. Boleteria	C.B.	
Indicador de Andén	I.A.		Mapas de Red	M.R.	
Boca de Acceso	H				

	TITULO DEL PLANO
EST. J. M. ROSAS	
LINEA B	
PLANTA NIVEL VESTIBULO INFERIOR	
OBSERVACIONES	CODIGO DE ESTACION
Estación no formalizada	B-18-Ro

Lateral de Escalera: Sube a Vestíbulo Intermedio (Av. Monroe)

JM. Rosas

I



Lateral de Escalera: Baja desde Vestíbulo Intermedio (Av. Roosevelt)

JM. Rosas

2



Lateral de Escalera: Acciones Realizadas



Lateral de Escalera: Medidas (Av. Monroe)

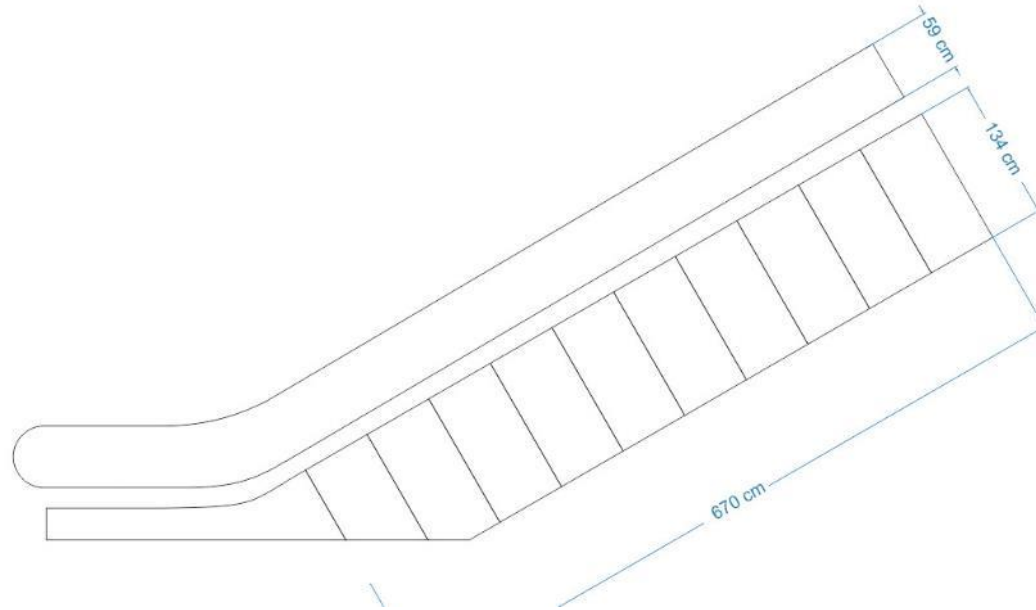

Lateral de Escalera: Medidas (Av. Roosevelt)

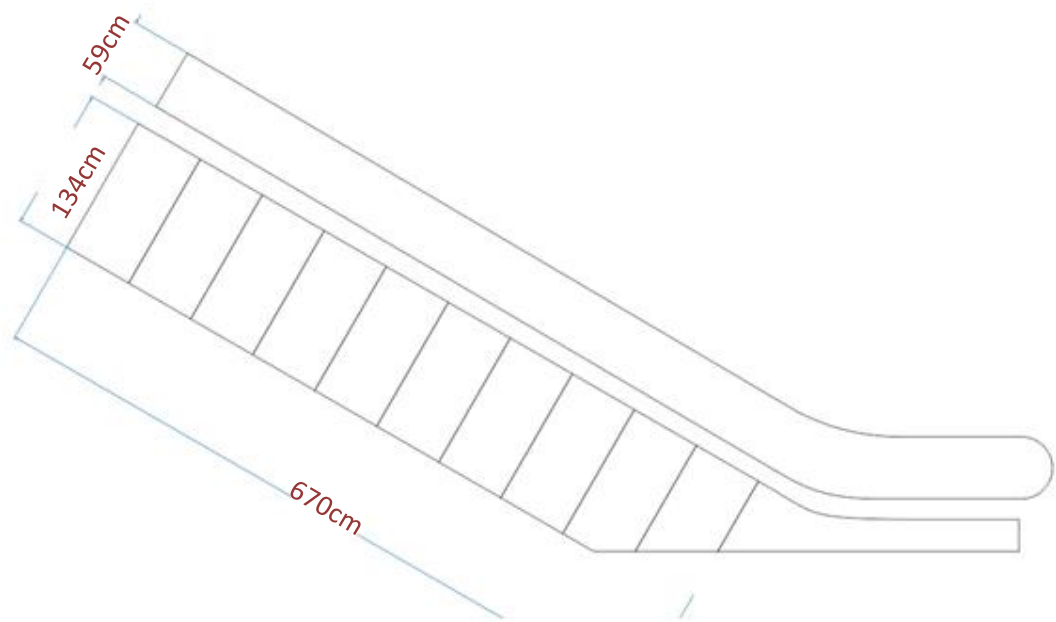

Lateral de Escalera: LÍNEA D

Olleros

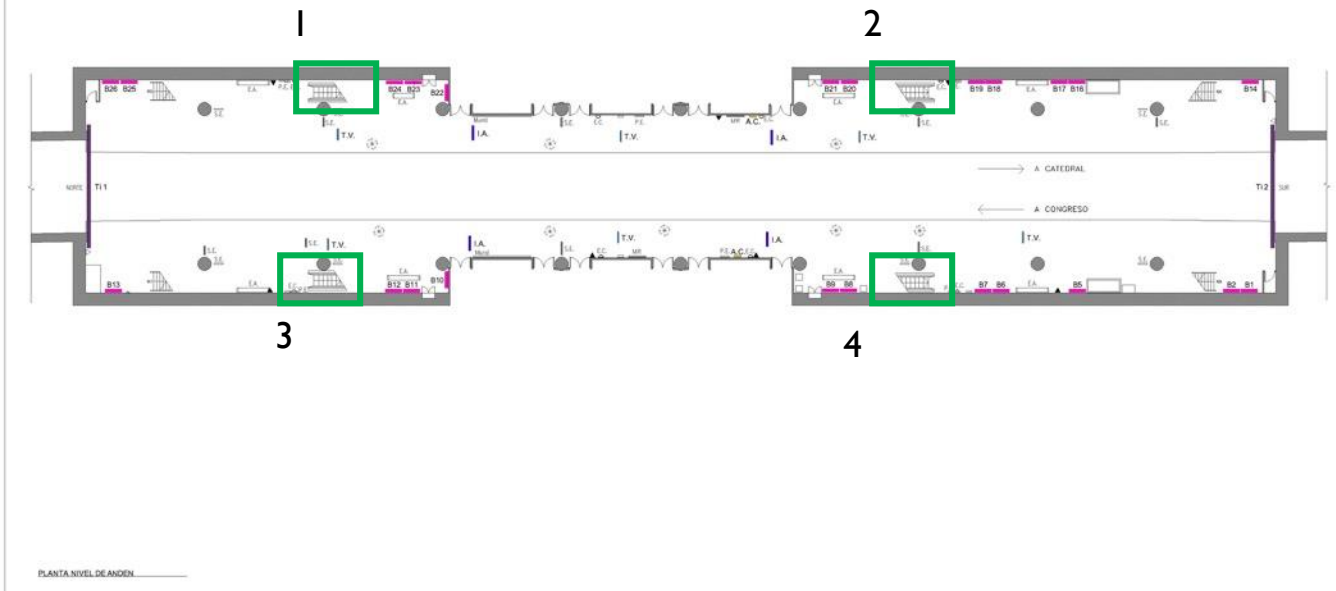

NOMENCLATURA DE LOS CARTELES PUBLICITARIOS					
Estatic Light Horizontal	B		Tímpano	TI	
Estatic Light Vertical	C		Plano de Evacuación	P.E.	
Estatic Classic	E		Rejo	R.	
SUBTV	T.V.		Equipamiento Asiento	E.A.	
Indicador de Andén	I.A.		Equipamiento Cesto	E.C.	
Boca de Acceso	H		Señalética	S.E.	
Promostep	K		Carti, Boletería	C.B.	
Atención Ciudadana	A.C.		Mapas de Red	M.R.	

TITULO DEL PLANO	
EST. OLLEROS LINEA D	
PLANTA NIVEL ANDÉN	
OBSERVACIONES	CODIGO DE ESTACION
Estación Terminalizada	D-14-011



Lateral de Escalera: Ubicación Hacia Catedral

Olleros

1

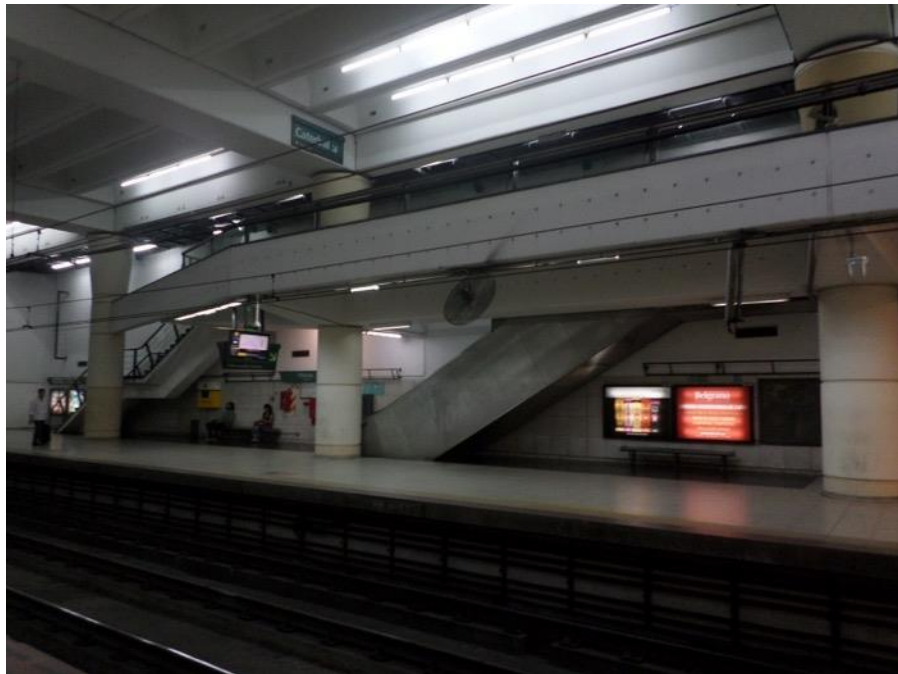

2





Lateral de Escalera: Ubicación Hacia Congreso de Tucumán

3

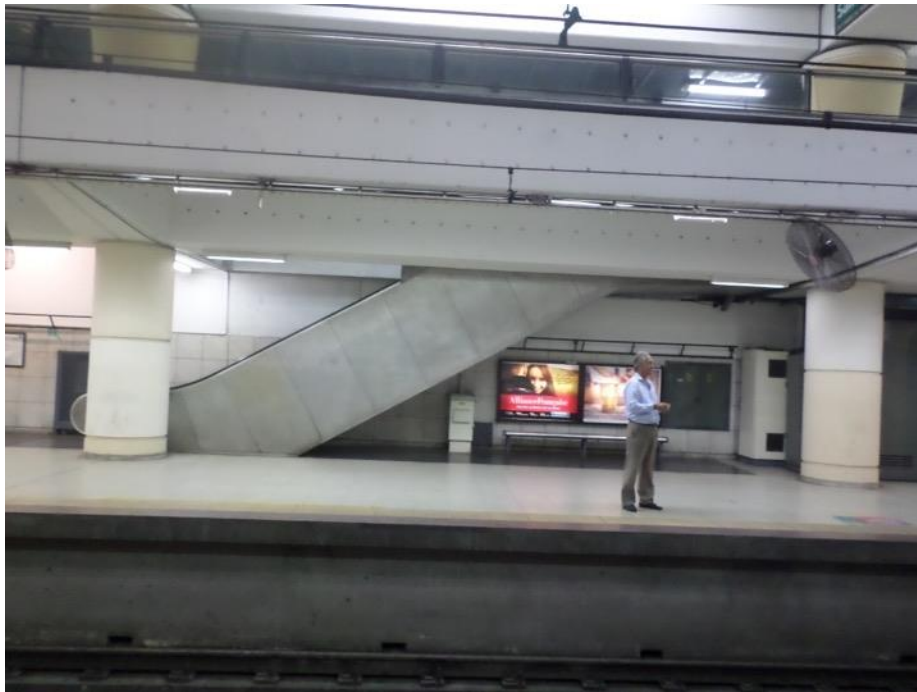

4

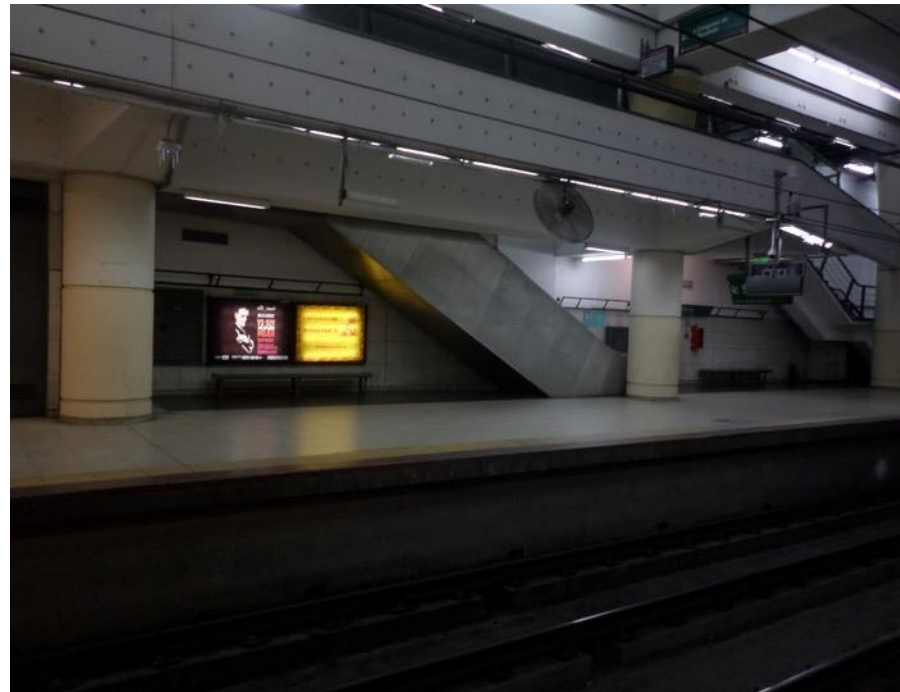

Lateral de Escalera: Acciones Realizadas



Lateral de Escalera: Medidas (1 y 4)

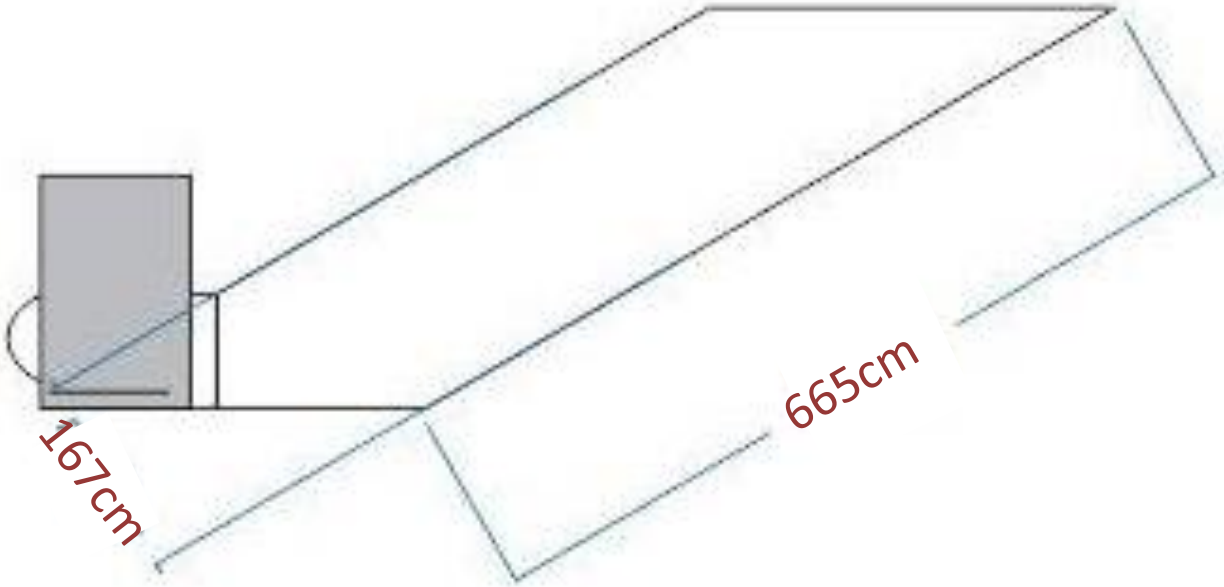

Lateral de Escalera: Medidas (2 y 3)

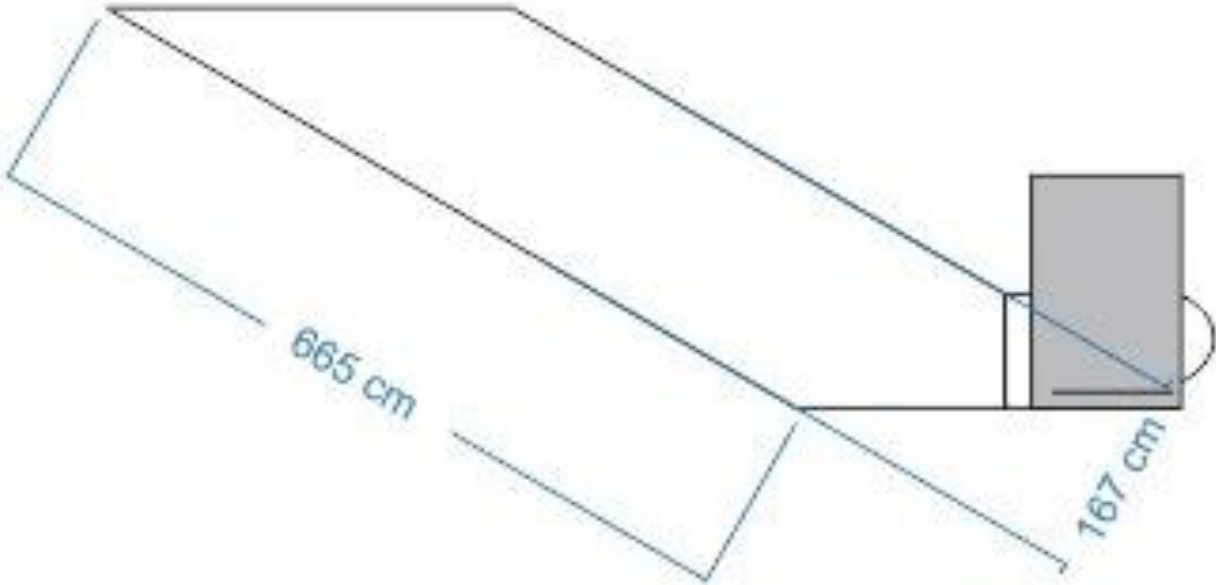

Lateral de Escalera: Hacia Catedral

José Hernández

1

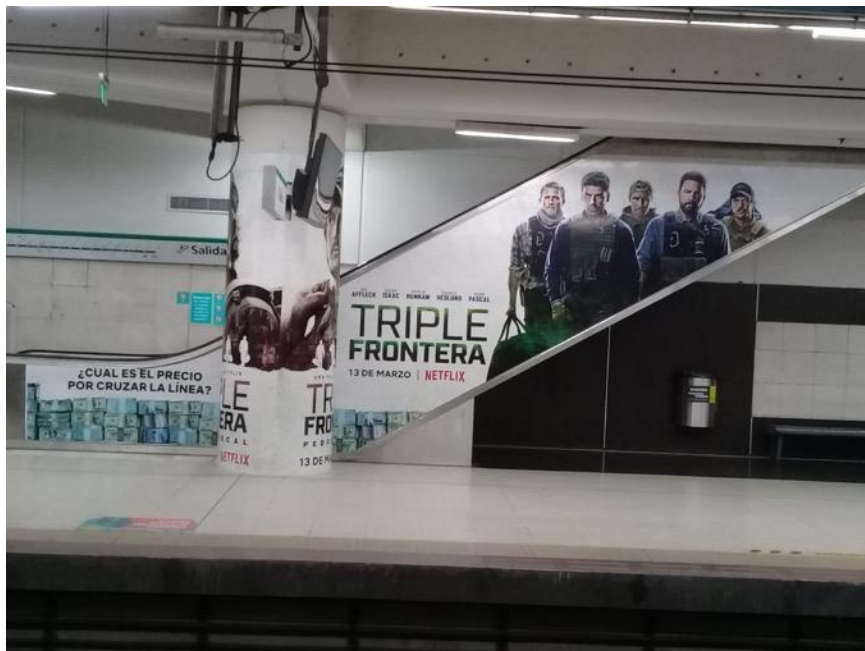

2



Lateral de Escalera: Hacia Congreso de Tucumán

Jose Hernandez

3



4

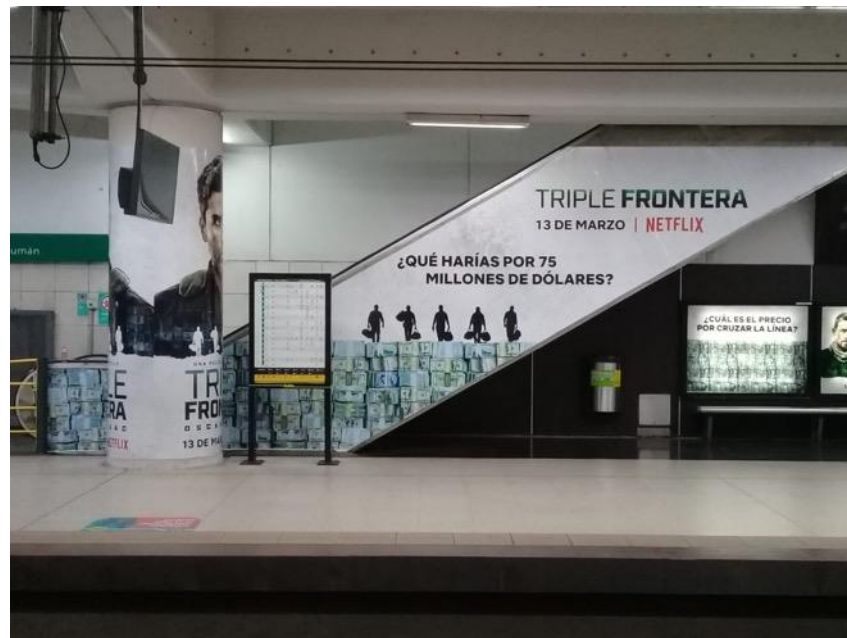

Lateral de Escalera: Medidas (1 y 4)

1

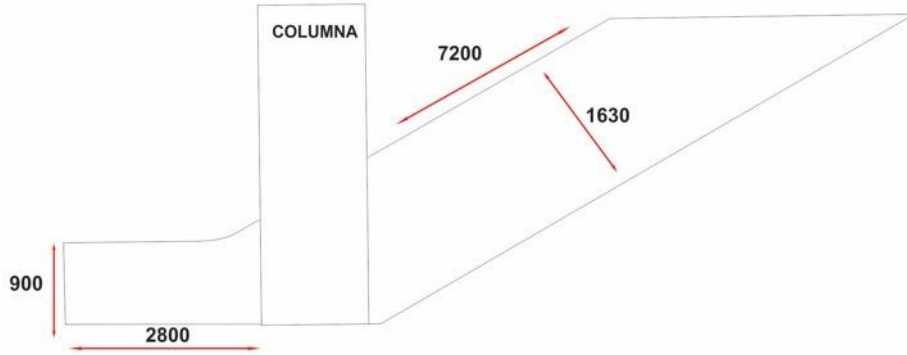

4

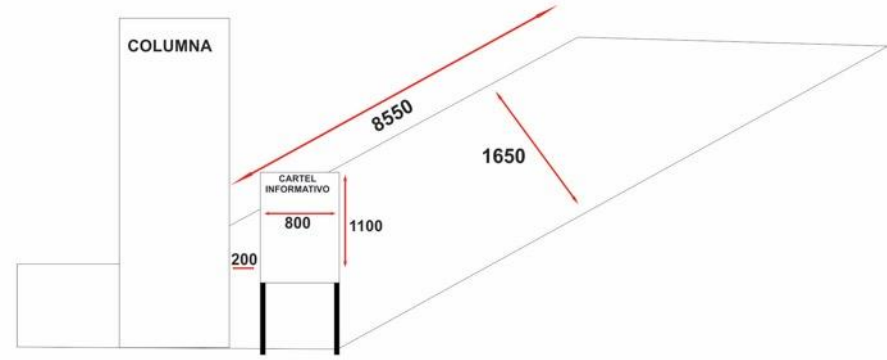



Lateral de Escalera: Medidas (2 y 3)

2

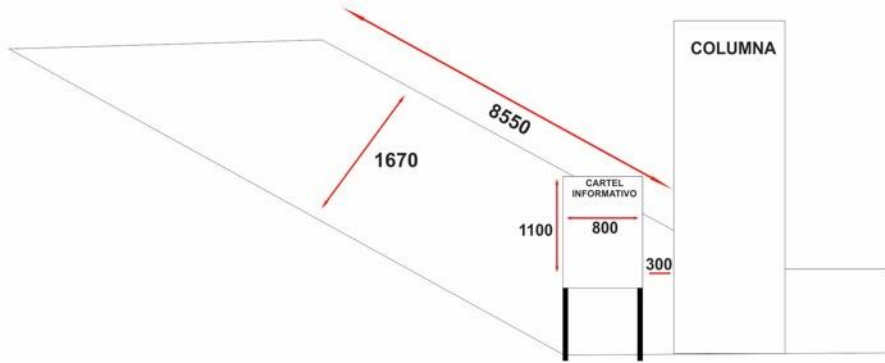

3

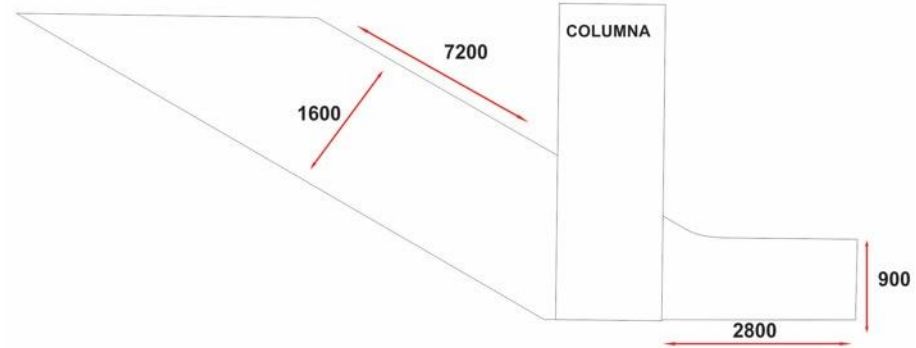



Lateral de Escalera

Juramento

Baja desde vestíbulo

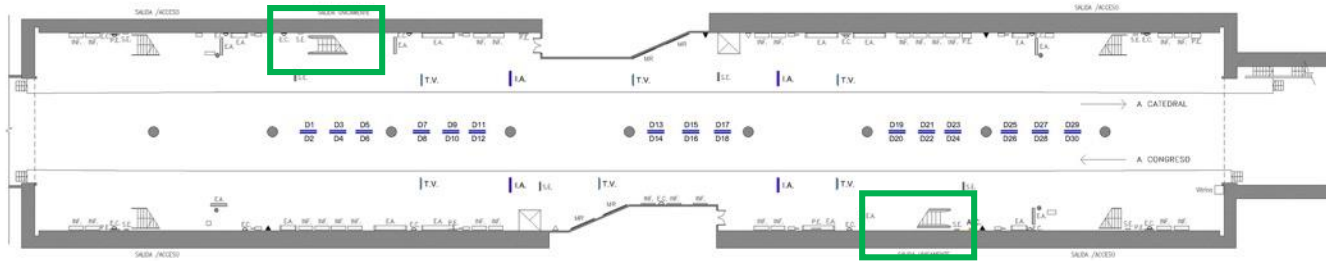

Sube a vestíbulo

PLANTA NIVEL DE ANDÉN

NOMENCLATURA DE LOS CARTELES PUBLICITARIOS					
Doble Faz Entrevías	D		Piano de Evacuación	P.E.	
SUBTV	T.V.		Equipamiento Asiento	E.A.	
Indicador de Andén	I.A.		Equipamiento Cesto	E.C.	
Boca de Acceso	H		Señalética	S.E.	
Promostep	K		Infografía	INF.	
Atención Ciudadana	A.C.		Mapas de Red	M.R.	

	TITULO DEL PLANO
EST. JURAMENTO LINEA D	
PLANTA NIVEL ANDEN	
OBSERVACIONES	CODIGO DE ESTACION
Estación Tematizada	D-16-Ju

Lateral de Escalera: Ubicación Hacia Catedral

Juramento



Lateral de Escalera: Ubicación Hacia Congreso de Tucumán

Juramento





Lateral de Escalera: Acciones Realizadas Hacia Catedral

Juramento



Lateral de Escalera: Acciones Realizadas Hacia Congreso de Tucuman





Lateral de Escalera: Medidas (2 y 3)

Juramento

